

SD60SPW1-RGY-N2P

Mind O≠0, I≠I≠1, S≠5, B≠8.

Supply voltage	14...30 V _{DC}
Reverse polarity protection	built-in
Power consumption	≈1.2 W
Maximum input current	< 180 mA
Recommended max. frequency	25 Hz
LED colors	red λ=625 nm green λ=525 nm yellow λ=592 nm
Operating temperature	-40...+50 °C
Protection class	IP 67
Housing material	stainless steel 1.4404
Bulb material	polycarbonate
Mounting hole Ø	22.5 mm
Mounting thread Ø	M18×1
Connection	2 m cable
Complies with	CE 

Signal Dome LED Indicator Stainless steel 1.4404 Control input: *Power input 1*



The photos show the same model with M12 male connector.

Wiring diagram

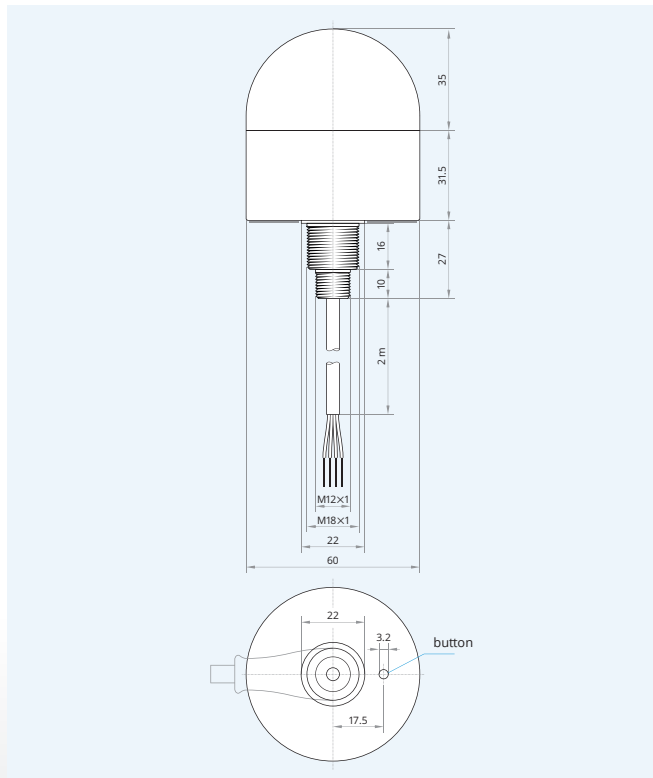
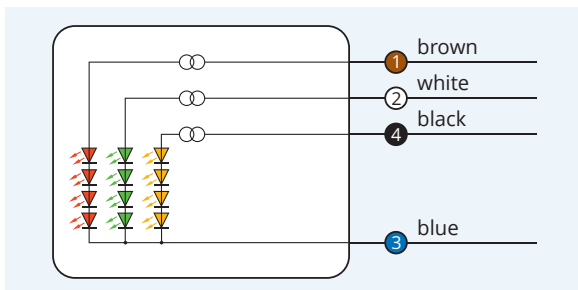

Caution! This shall not be used
as a safety device.

TR Electronic reserves the right to make minor changes without prior notification.